

P/N: FAPE3018115

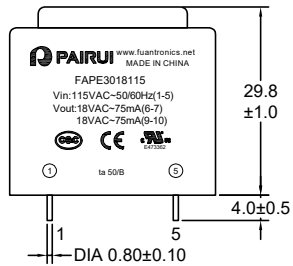

Outline Dimensions(Unit:mm)



Front View

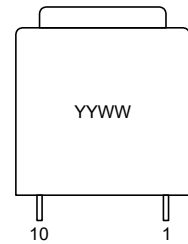

Side View

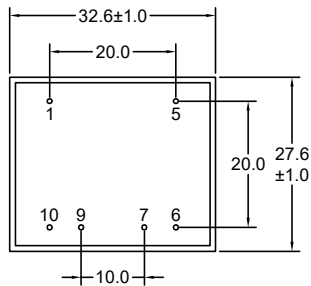

Bottom View

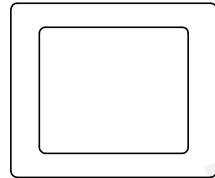

Top View

Note:

- 1.Remove Pins 2,3,4,8.

Wave Soldering

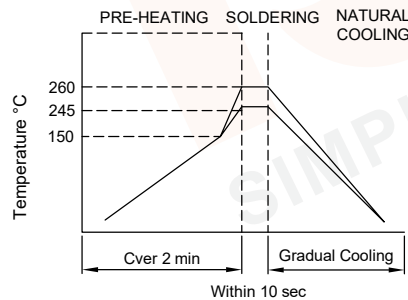

- Note:
- 1.Never Contact the ceramic with the iron tip;
  - 2.1.0mm tip diameter(max).

Electronical Schematic

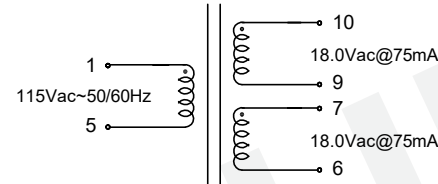

Electrical Characteristics

- Input 115Vac 60Hz to 1-5 :  
 Excitation current(Ix):12.0mA Max.  
 Output: Vo(6-7)=30.9Vac Typ(No-load).  
 Vo(9-10)=30.9Vac Typ(No-load).  
 VL(6-10 short7,9)=36.0Vac±5%(Series@75mA).  
 VL(6,9-7,10)=18.0Vac±5%(Parallel@150mA).  
 Insulation Resistance: Pri-Sec:100 Mohms Min @500V.  
 Hi-Pot: Pri-Sec:4000VAC/5mA/60Second.

General Properties

- Operating Temperature:-25°C to +50°C.  
 Storage Temperature:-25°C to +85°C.  
 Insulation Class: B.

|     |             |      |      |   |   |   |   |  |
|-----|-------------|------|------|---|---|---|---|--|
| REV | DESCRIPTION | APPD | DATE | Tianchang Fuan Electronic Co Ltd<br>www.fuantronics.net<br>TEL: +86-550-7814888<br>FAX: +86-550-7831133 | Tolerances unless otherwise specified:<br>(X)±0.50 (XX)±0.25<br>Unit of measurement: mm | Make: Qiumei.Liu<br>Checked: Beson. zhan<br>Approved: Anson. zhan | <b>DRAWING TITLE</b><br>2.70W Encapsulated Transformer<br>For EI30*18,115VAC Input 50/60Hz<br>Material Number: A223018XS580 | Customer Name:<br>Document/Rev: 00<br>Specification Sheet: 1 of 3<br>Date of Recognition: Jan./02/2020 |
|     |             |      |      |   |   |   |   |  |
|     |             |      |      |   |   |   |   |  |

P/N: FAPE3018115

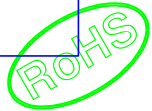

List of UL Certificate:

| No. | Part Name   | Mat'l Description         | Supplier                            | UL Number |
|-----|-------------|---------------------------|-------------------------------------|-----------|
| 1   | Bobbin      | EI30*18/PBT(Black)        | Chang Chun Plastics Co Ltd          | E59481    |
| 2   | Case        | CASE-EI30*18/PA66(Orange) | Zhejiang Juner New Materials Co Ltd | E204321   |
| 3   | Copper wire | 2UEW-F/155C               | Elektrisola Hangzhou Co Ltd         | E258243   |
| 4   | Core        | Lamination                | Ta Yea Steel Industry Co Ltd        | N/A       |
| 5   | Epoxy       | PU552(Black)              | Wevo-Chemle Gmbh                    | E108835   |
| 6   |             |                           |                                     |           |

Packaging Specification:

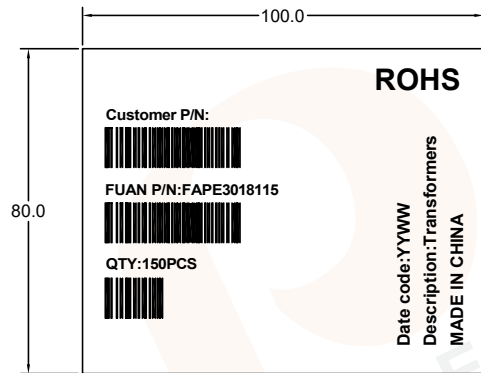

Laber of outer

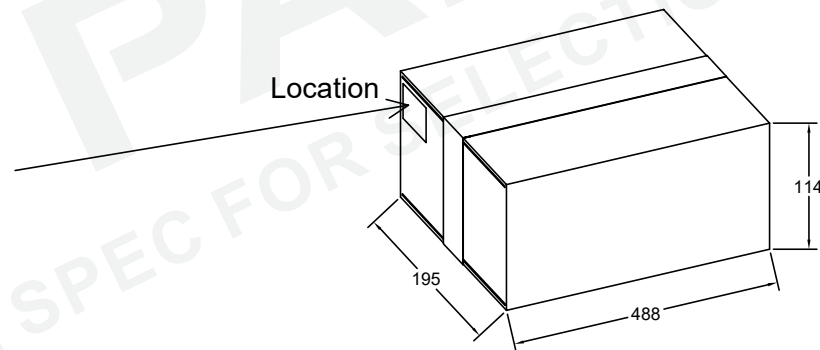

put the label on the top left corner of one of the carton sides

|     |             |      |      |   |  |   |   |  |
|-----|-------------|------|------|---|--|---|---|--|
|     |             |      |      | Tianchang Fuan Electronic Co Ltd<br>www.fuantronics.net<br>TEL: +86-550-7814888<br>FAX: +86-550-7831133 | <br>Tolerances unless otherwise specified:<br>(.X)±0.50 (XX)±0.25<br>Unit of measurement: mm | Make: Qiumei.Liu<br>Checked: Beson. zhan<br>Approved: Anson. zhan | <b>DRAWING TITLE</b><br>2.70W Encapsulated Transformer<br>For EI30*18,115VAC Input 50/60Hz<br>Material Number: A223018XS580 | Customer Name:<br>Document/Rev: 00<br>Specification Sheet: 2 of 3<br>Date of Recognition: Jan./02/2020 |
| REV | DESCRIPTION | APPD | DATE |   |  |   |   |  |

P/N: FAPE3018115

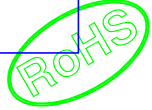

Packing Method:

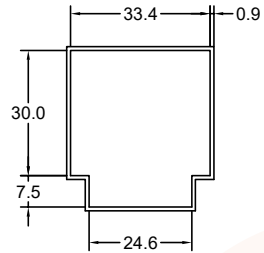
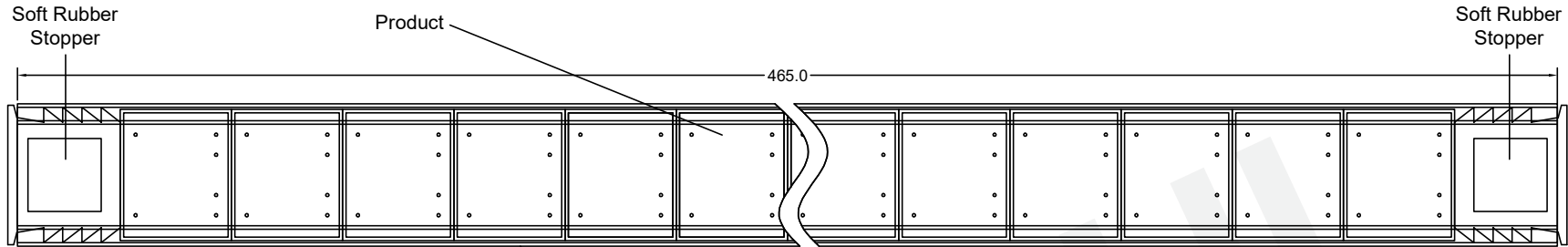

Size of packaging tube:  
465mm\*35.2mm\*39.3mm  
(Length \* Width \* Height)

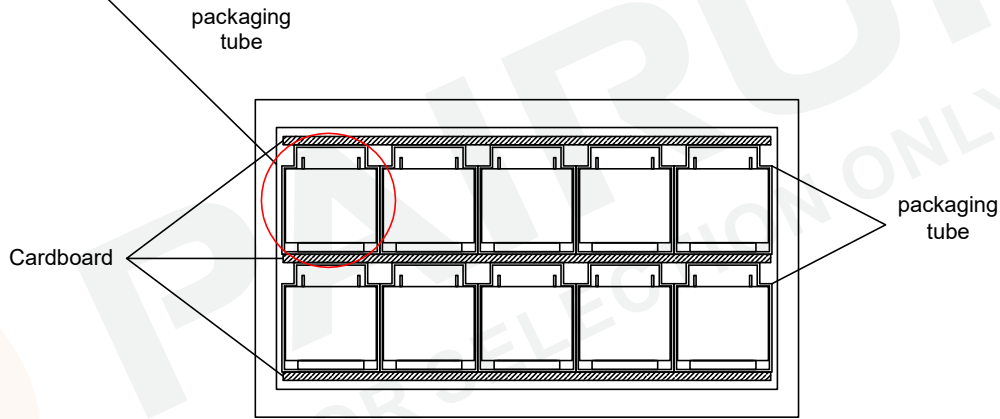

Carton Box Side View

| Layer/Carton | Quantity/Tube (pcs) | Quantity/Carton (pcs) | Net weight (g/pc) | Gross weight (g/tube) | Tubes/carton (pcs) | Total weight (kg) | box size Dimensions (mm) |
|--------------|---------------------|-----------------------|-------------------|-----------------------|--------------------|-------------------|--------------------------|
| 2.0          | 15.0                | 150.0                 | 115.0             | 90.40                 | 10.00              | 18.72             | 488*195*114              |

| REV | DESCRIPTION | APPD | DATE |
|-----|-------------|------|------|
|     |             |      |      |

Tianchang Fuan Electronic Co Ltd  
www.fuantronics.net  
TEL: +86-550-7814888  
FAX: +86-550-7831133

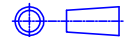

Tolerances unless otherwise specified:  
(.X)±0.50 (XX)±0.25  
Unit of measurement: mm

Make: Qiumei.Liu  
Checked: Beson. zhan  
Approved: Anson. zhan

**DRAWING TITLE**  
2.70W Encapsulated Transformer  
For EI30\*18,115VAC Input 50/60Hz  
Material Number: A223018XS580

Customer Name:  
Document/Rev: 00  
Specification Sheet: 3 of 3  
Date of Recognition: Jan./02/2020